

Article number: 604146016037

Description: Timing belt pulley with hub
16 XL 037

Measures

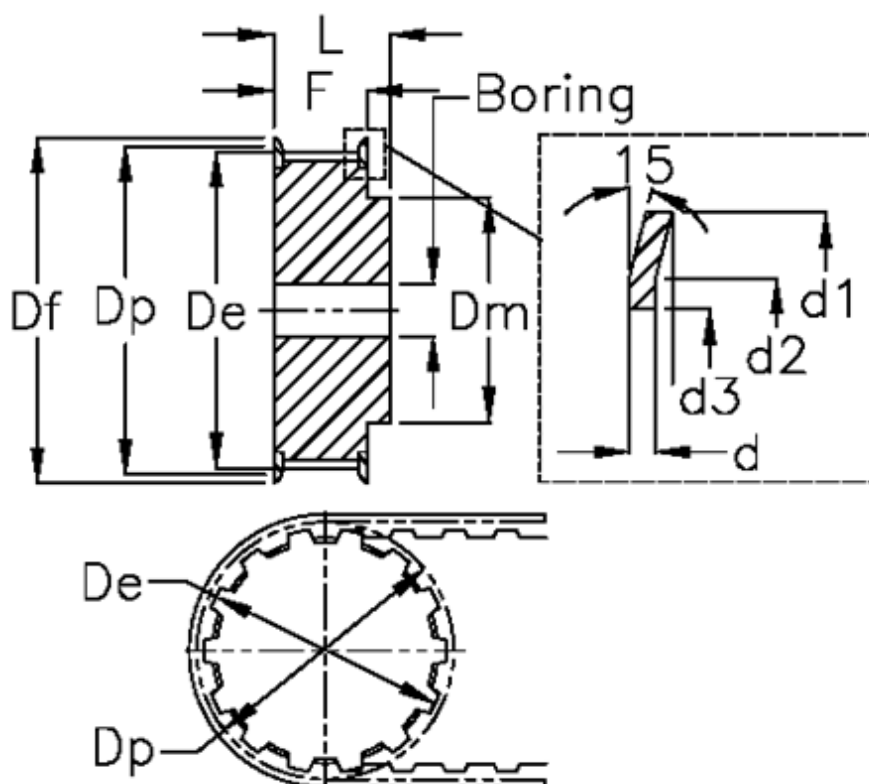

d = 1	F = 14.3	Width = XL 037
d1 = 32	Flange type = F10	
d2 = 27.5	L = 19.8	
d3 = 23	Max bore = 12.7	
De = 25.36	Pitch = 1/5"	
Df = 32	Pre-drilled = 6	
Dm = 17.5	Tooth number = 16	
Dp = 25.87	Weight = 0.05	